

KING OF THE STUNTMEN
EVEL Knievel™

CB VAN™

HEAR EVEL
TALK TO ALL
HIS GOOD
BUDDIES

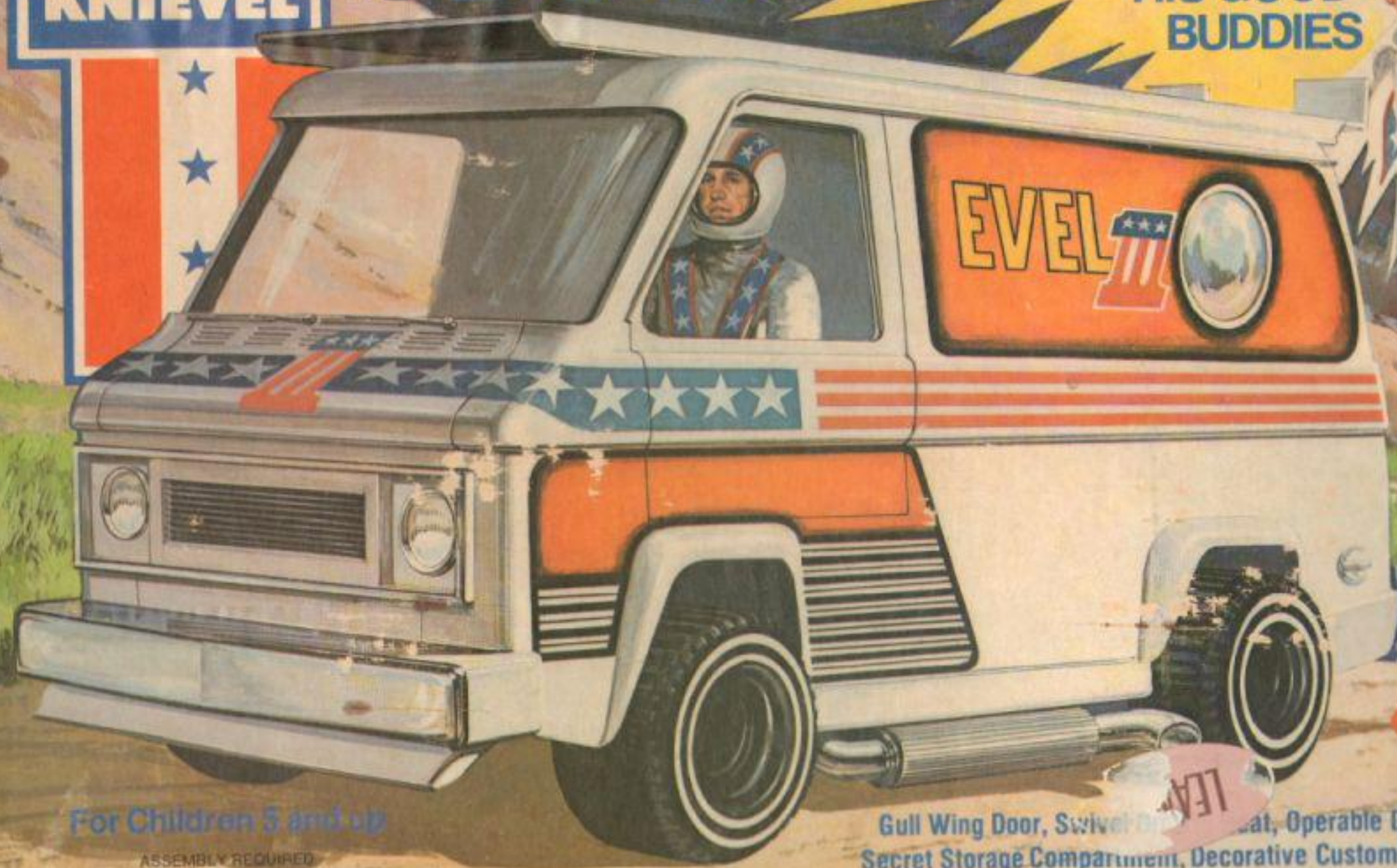

For Children 5 and up

ASSEMBLY REQUIRED



LEARN
Features:
Gull Wing Door, Swivel Driver's Seat, Operable Drivers Door,
Secret Storage Compartment, Decorative Customizing Labels.

Complete With: Battery Operated
C.B. Message Unit, Jump Ramp
And Universal Bike Rack to Fit
All Evel Knievel Bikes.

For Children 5 and up



CB VAN™

RAMP IS
ILLUSTRATED
OFFSET
TO SHOW
DOOR OPEN

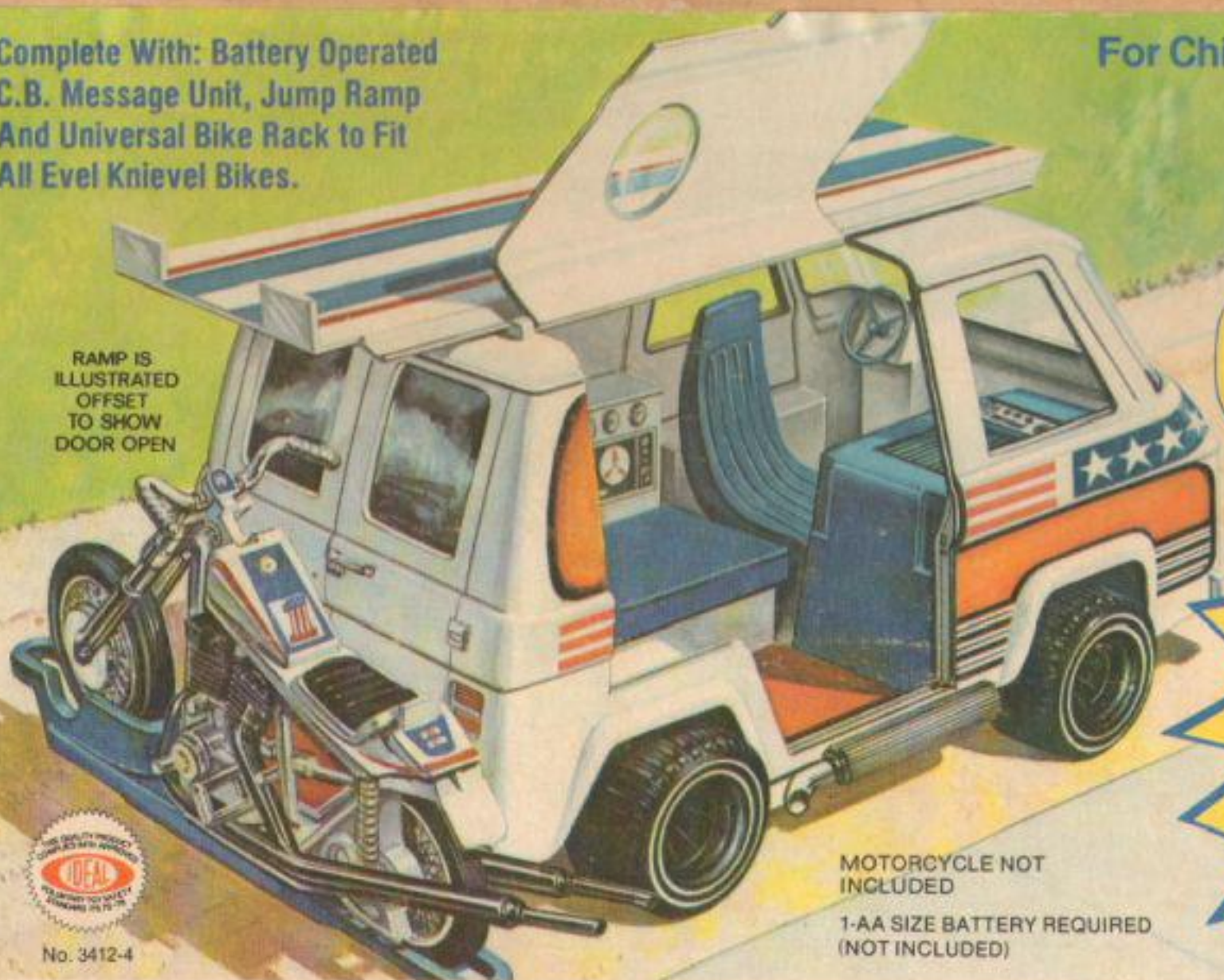

6
MESSAGES
HEAR EVEL TALK
TO ALL HIS GOOD
BUDDIES!



No. 3412-4

MOTORCYCLE NOT
INCLUDED

1-AA SIZE BATTERY REQUIRED
(NOT INCLUDED)

3L-0790

**HEY KIDS. BE SURE TO
VISIT YOUR LOCAL DEALER
AND SEE OTHER AVAILABLE
EVEL KNieVEL™ TOYS.**



Evel Knievel Stunt Cycle® 3407-4.

Evel Knievel roars out of the energizer on his realistically detailed Stunt Cycle and performs exciting wheelies, jumps and flips. The Gyro powered motor sends him racing over 100 feet at top speed. Complete with: figure, stunt cycle, G.T. wheelie stand, dare devil flip bar & energizer.



**Evel Knievel Strato Cycle™
3411-6.**

The Strato Cycle is an exact replica of the bike used in the movie "Viva Knievel". Does all s'unts stunt cycle does. Complete with figure and energizer.



Evel Knievel Chopper 3450-4.

Super detailed Chopper does all the tricks the Stunt Cycle does. Comes complete with energizer and figure.

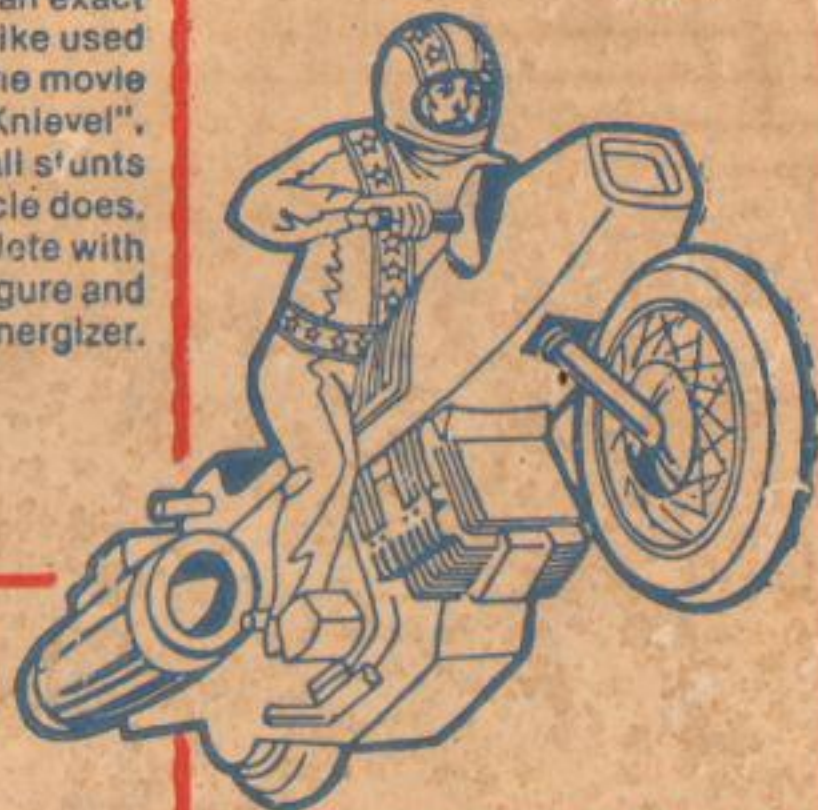

**Evel Knievel Super Jet Cycle™
3452-0.**

This sleek cycle's twin pods "blaze away" as it roars along. Its low profile gives it a classic racing look. It jumps and wheelies like other Evel Knievel vehicles. Complete with figure and energizer.

KING OF THE STUNTMEN
EVEL KNEIVEL

CB VAN™



Complete With: Battery Operated
C.B. Message Unit, Jump Ramp
And Universal Bike Rack to Fit
All Evel Knievel Bikes.



No. 3412-4

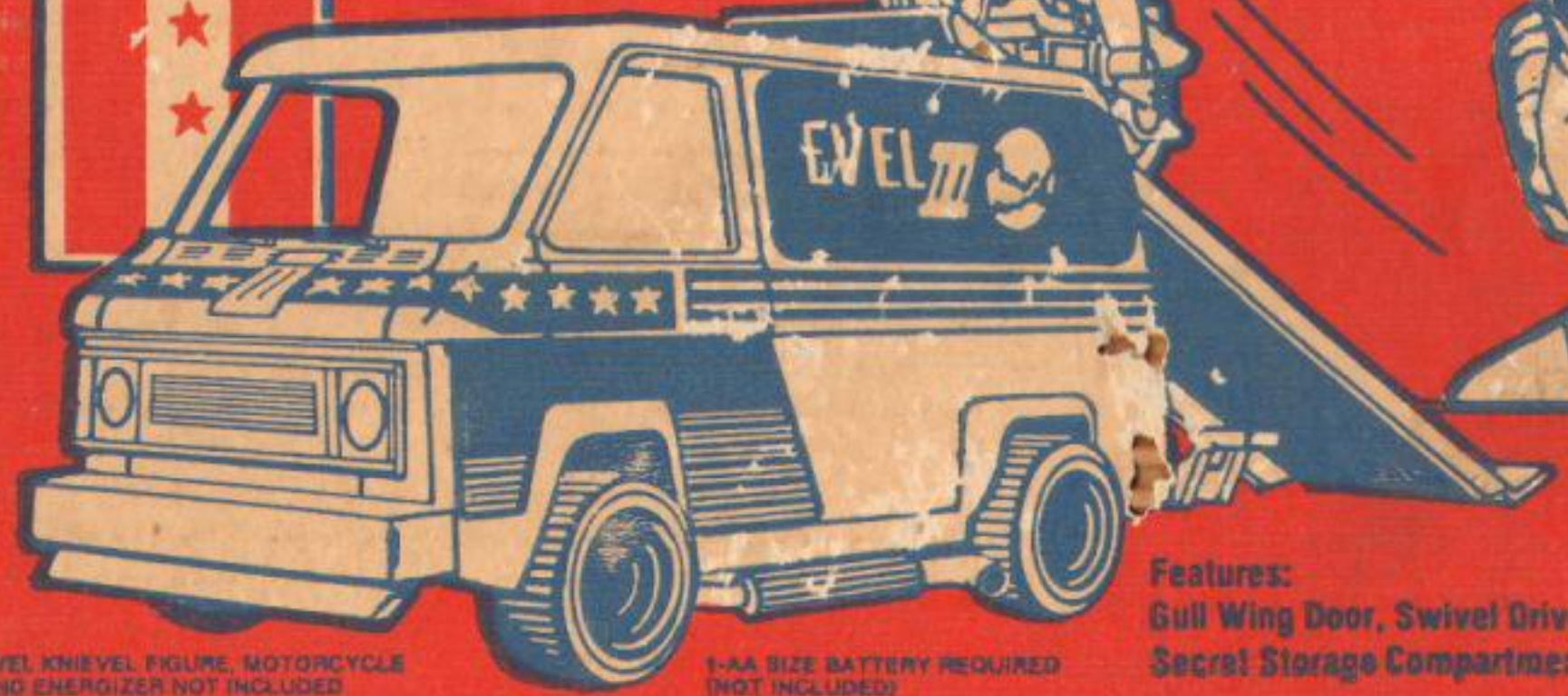

EVEL KNEIVEL FIGURE, MOTORCYCLE
AND ENERGIZER NOT INCLUDED

1-AA SIZE BATTERY REQUIRED
(NOT INCLUDED)

Features:
Gull Wing Door, Swivel Drivers Seat, Operable Drivers Door,
Secret Storage Compartment, Decorative Customizing Labels.

© 1977 IDEAL TOY CORP., HOLLIS, N.Y. 11420

KING
OF THE
STUNTMEN

EVEL
KNIEVEL

CB VAN™



No. 3412-4

Features:

Gull Wing

Secret S

MOTORCYC



ers Seat, Operable Drivers Door,
nt, Decorative Customizing Labels.

KING
OF THE
STUNNERS

LEVEL
KNIEVEL

CB VAN



DEAL

No. 2412-4

Features:

Gull Wing Door, Swivel Drivers Seat, Operable Drivers Door,
Secret Storage Compartment, Decorative Customizing Labels.

MOTORCYCLE NOT INCLUDED















EVEL



For Children 5 and Up

THE KING OF THE STUNNERS
KNIEVEL
CB VAN

6 MESSAGES
HEAR EVEL TALK
TO ALL HIS GOOD
BUDDIES!

Complete With: Battery Operated
C.B. Message Unit, Jump Ramp
And Universal Bike Rack to Fit
All Evel Knievel Bikes.

RAMP IS
ILLUSTRATED
OFFSET
TO SHOW
DOOR OPEN

MOTORCYCLE NOT
INCLUDED
1.5A SIZE BATTERY REQUIRED
(NOT INCLUDED)

HEAR EVEL
TALK TO ALL
HIS GOOD
BUDDIES



No. 34124

© 1977 Ideal Toy Corporation, Hollis, New York 11463

CB VAN

EVEL

THE KING OF THE STUNNERS
KNIEVEL

CB VAN



THE KING OF THE STUNNERS
KNIEVEL



THE
EVEL
KNIEVEL

C.B. WANN



Complete With: Battery Operated
C.B. Message Unit, Jump Ramp
And Universal Bike Rack to Fit
All Evel Knievel Bikes.



Features:
Gull Wing Door, Swivel Drivers Seat, Operable Drivers Door,
Secret Storage Compartments, Decorative Customizing Labels.

© 1971 IDEAL TOY CORP. HOLLIS, N.Y. 11423

1 AA SIZE BATTERY REQUIRED
(NOT INCLUDED)



C.B. WANN







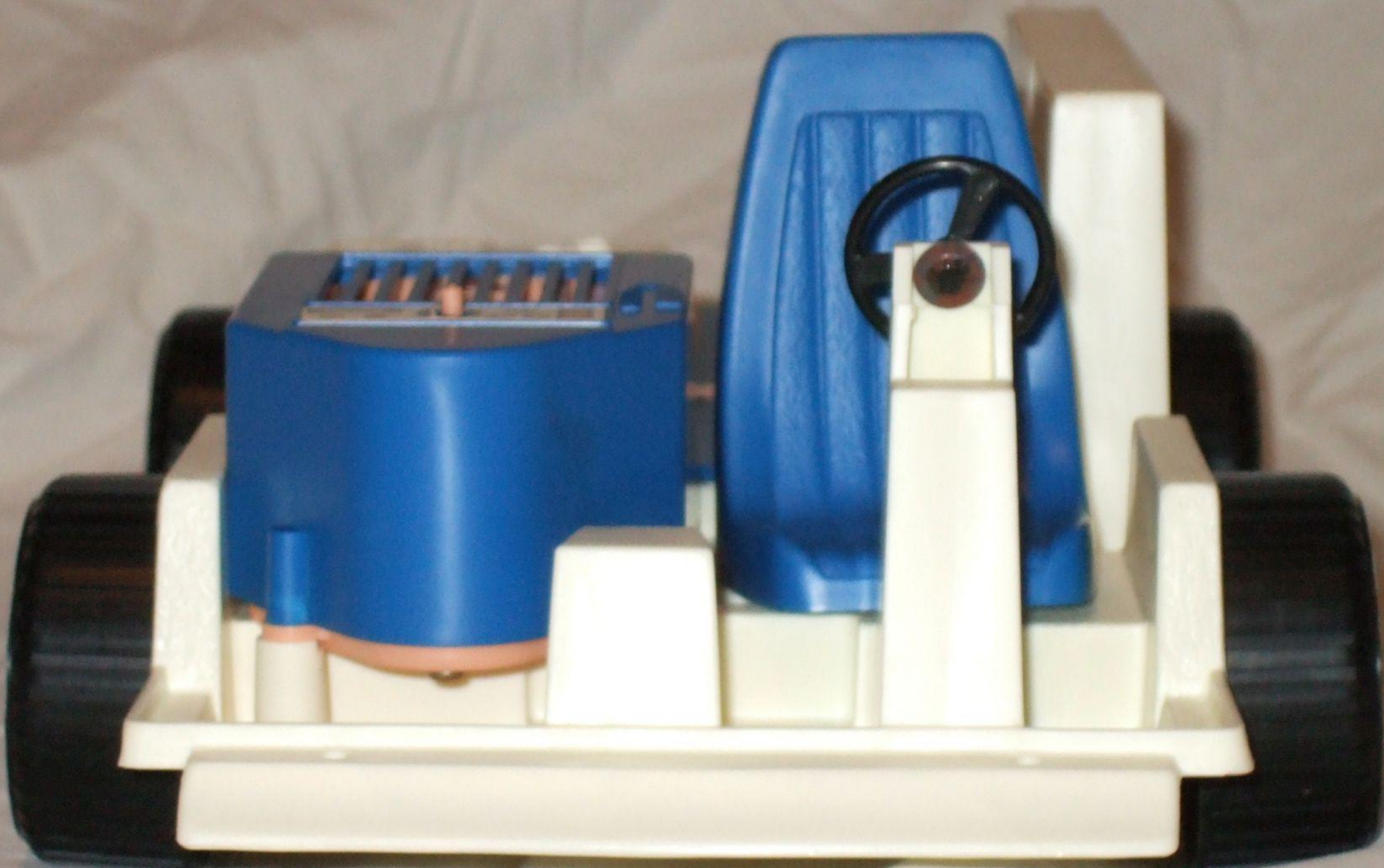

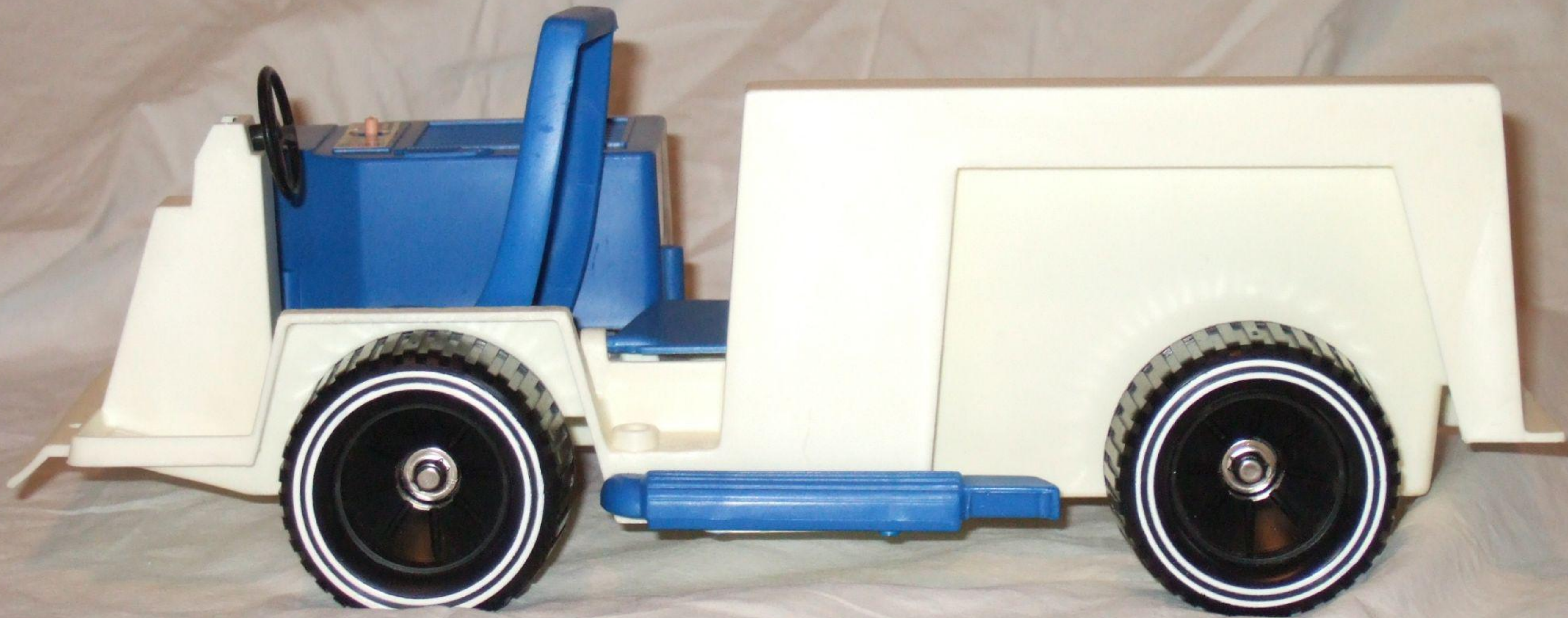





7M-6264-01













6266-01











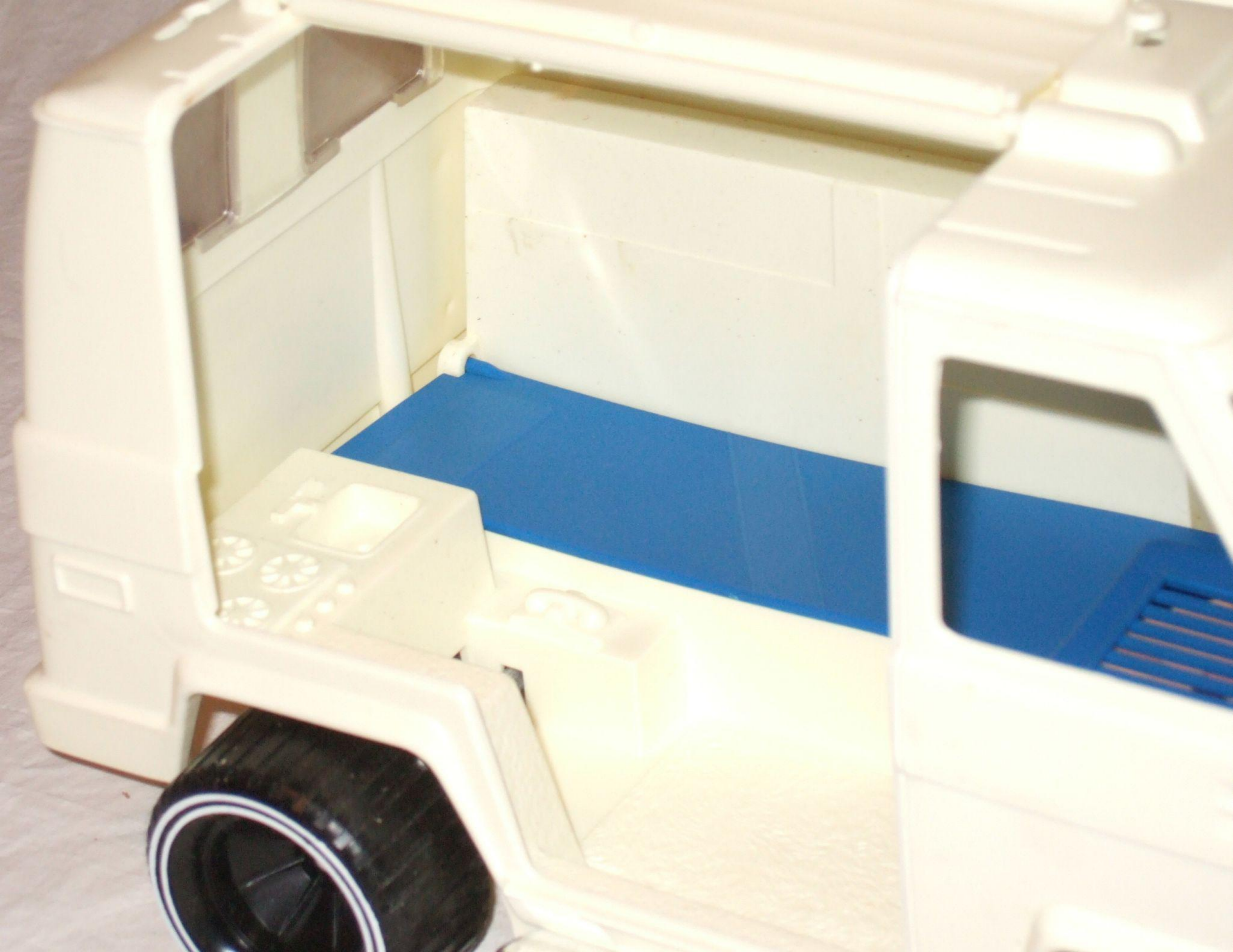











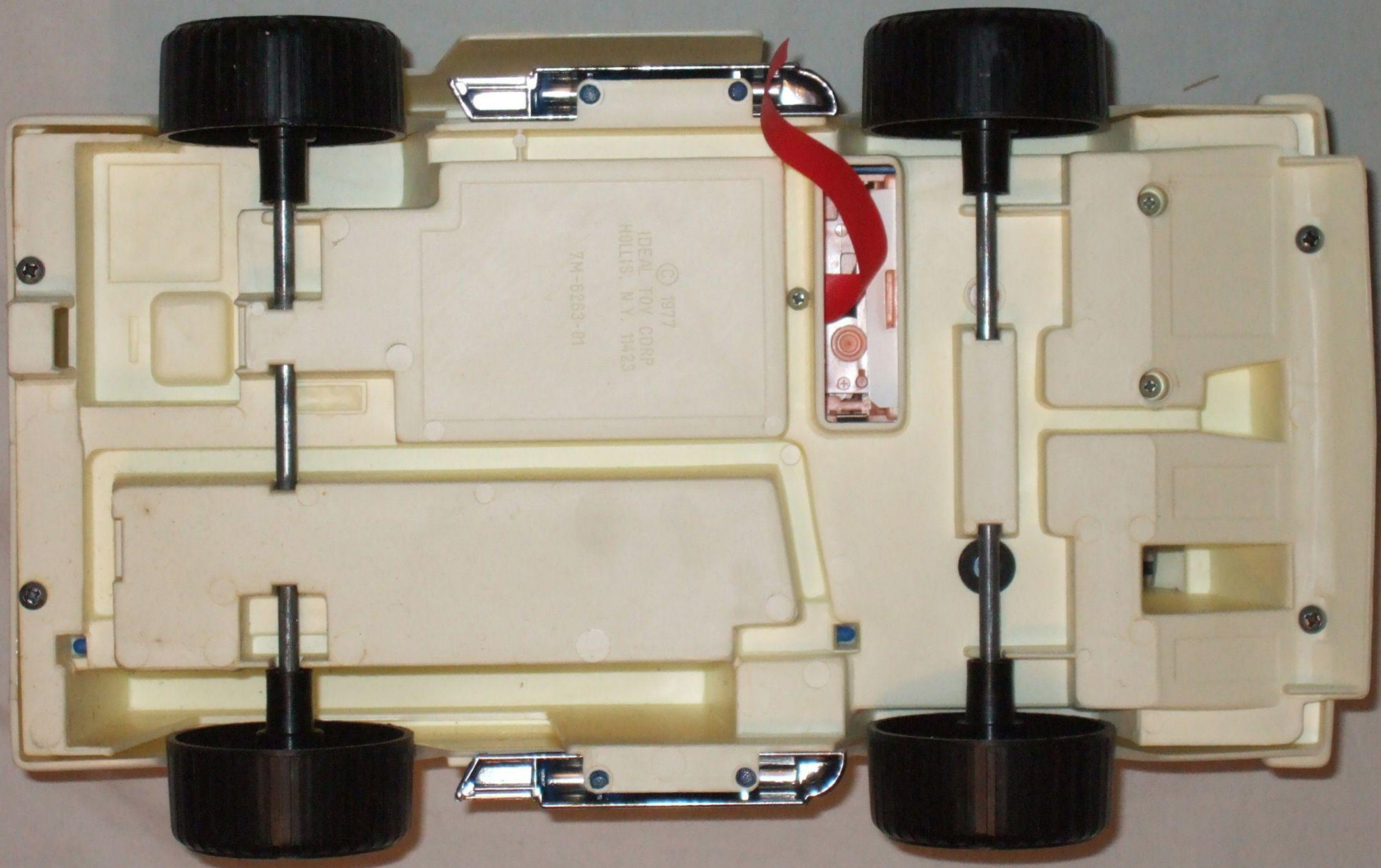

© 1977
IDEAL TOY CORP.
HOLLIS, N.Y. 11423
7M-6263-01

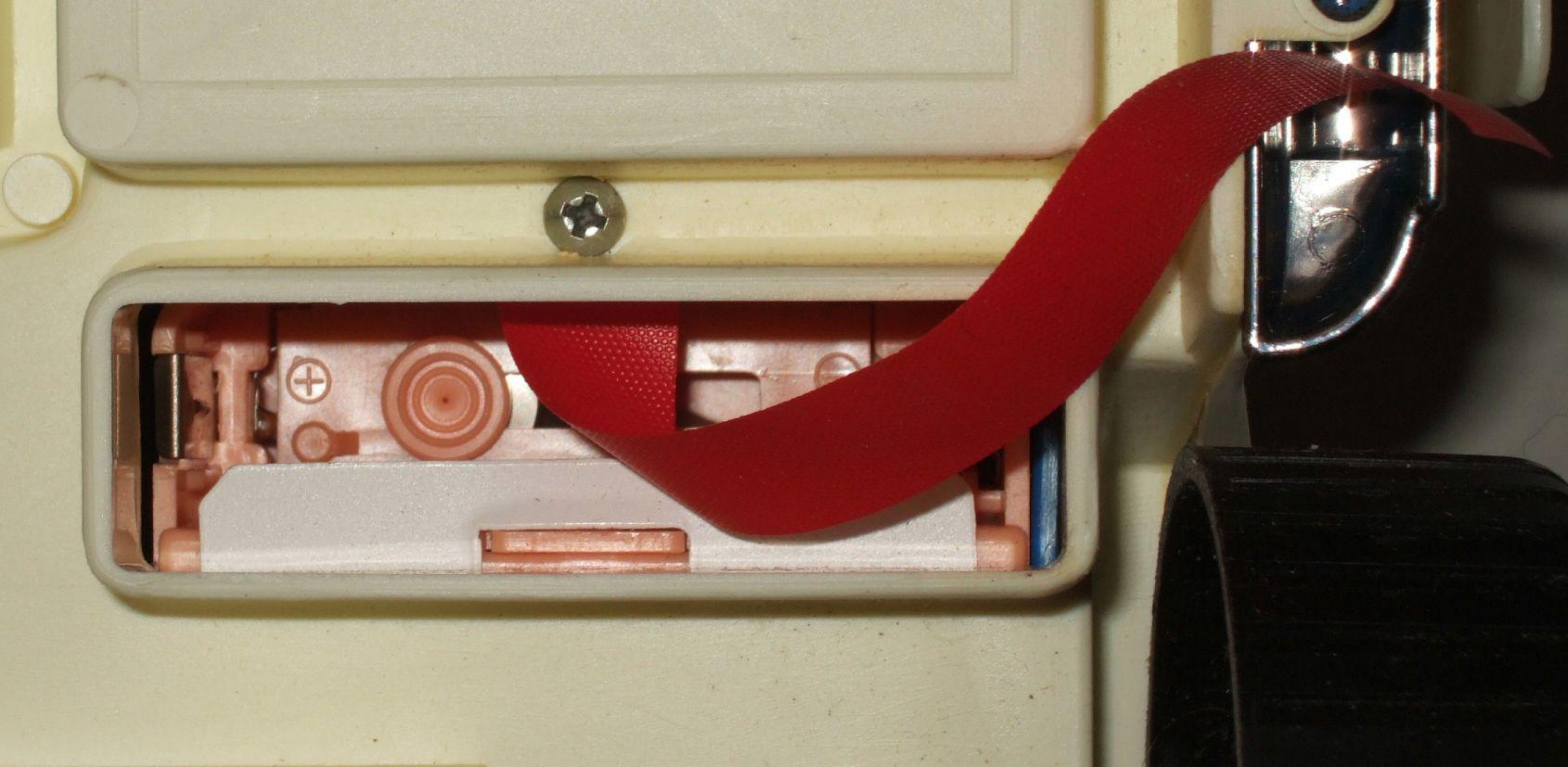



PLEASE NOTE: REFER TO INSTRUCTION SHEET FOR EXACT PLACEMENT OF EACH LABEL.



RAMP
→ REAR DRIVER SIDE
→ REAR PASSENGER SIDE

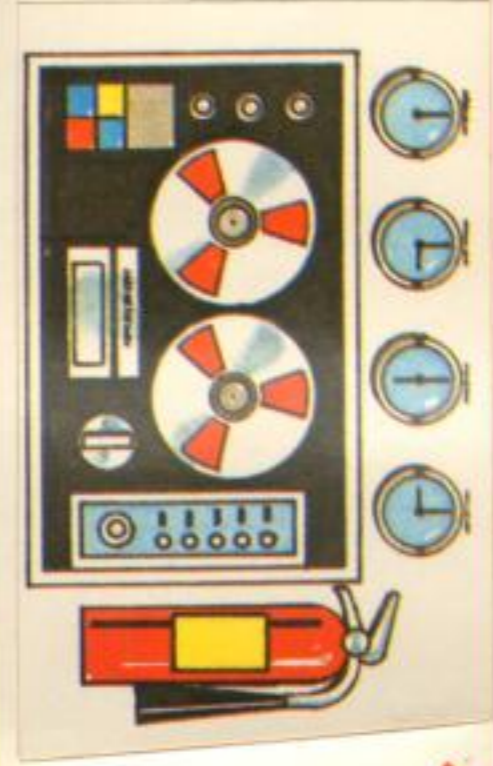

FRONT DRIVER SIDE →
INSIDE WALL

FRONT PASSENGER SIDE →
MOUNT ON MATTRESS

PILLOW →

MOUNT ON HOOD

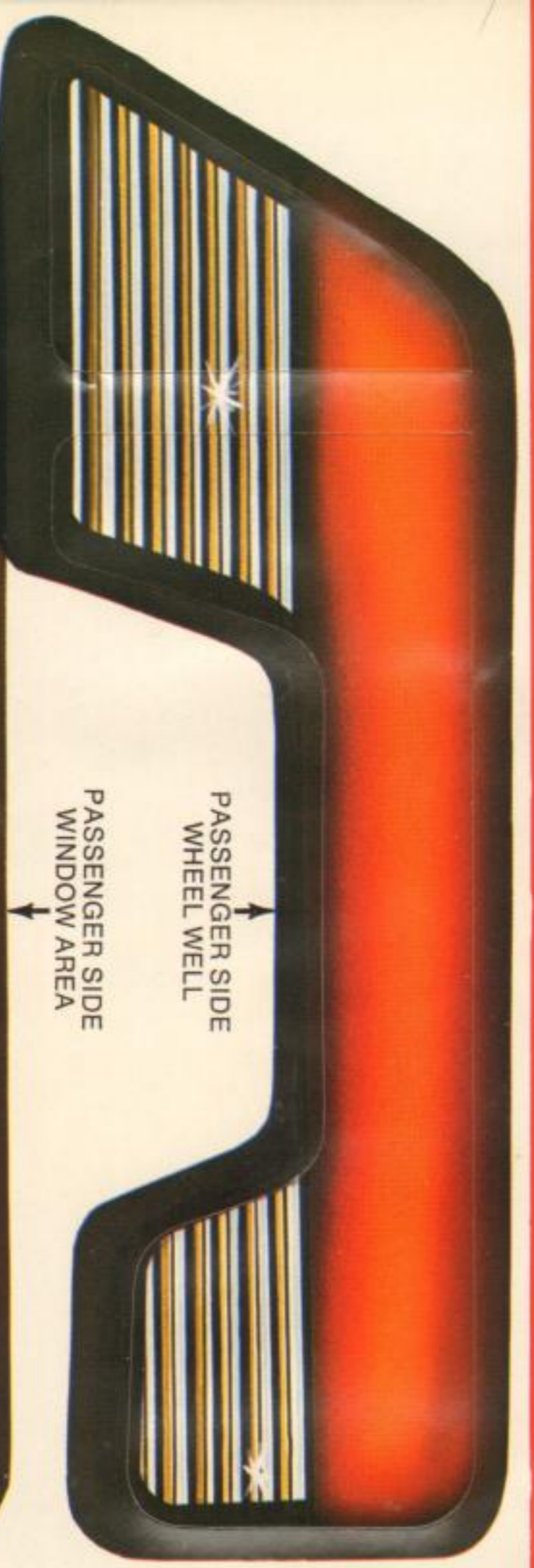

PASSENGER SIDE WHEEL WELL
PASSENGER SIDE WINDOW AREA

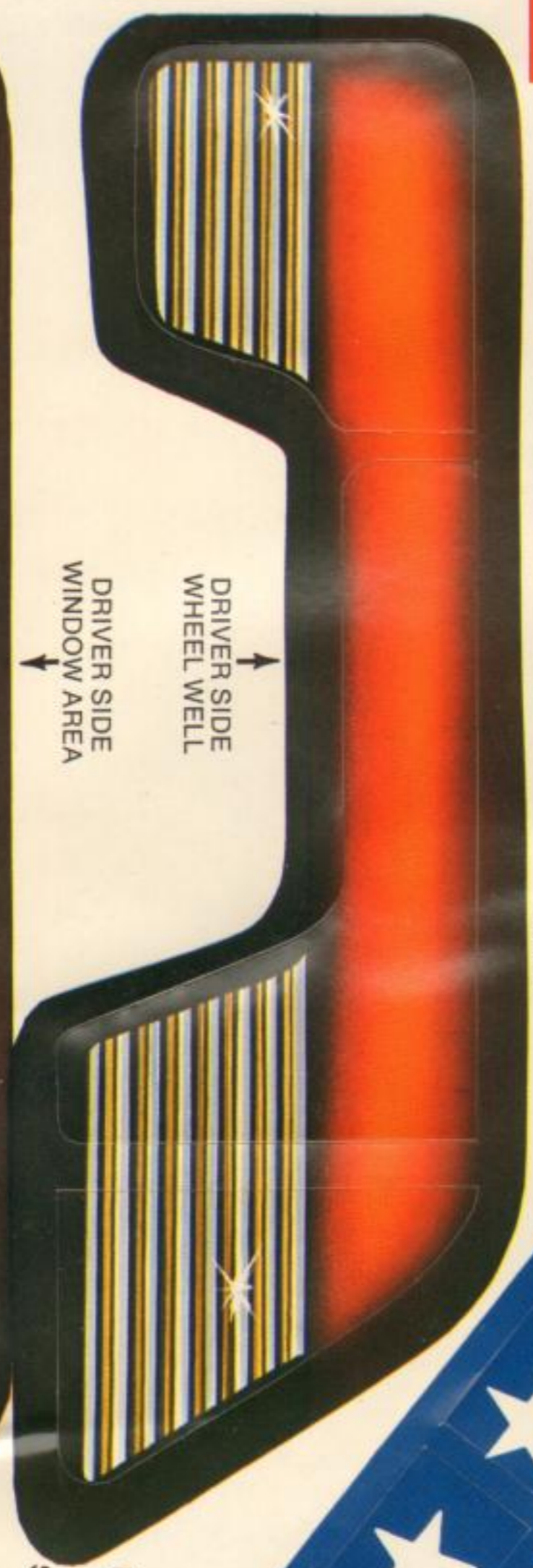

DRIVER SIDE WHEEL WELL
DRIVER SIDE WINDOW AREA

MOUNT OVER VOICE SWITCH

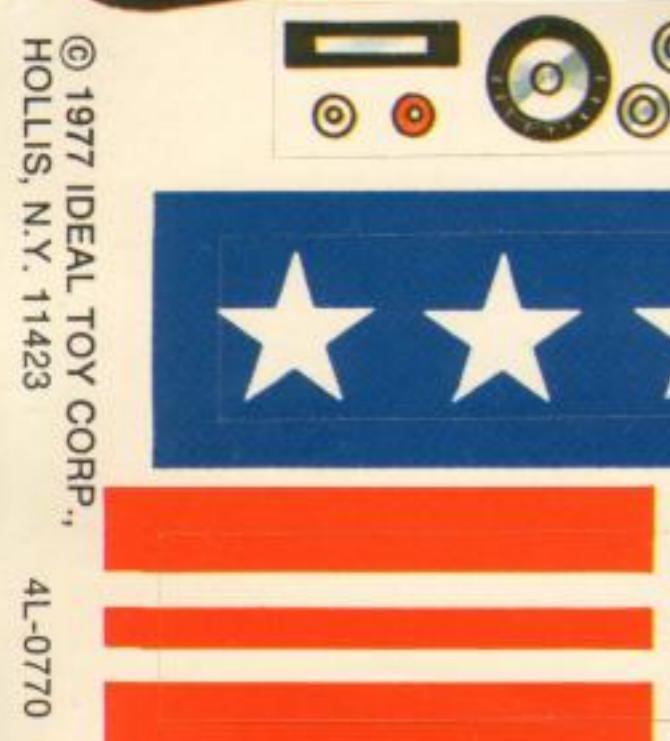
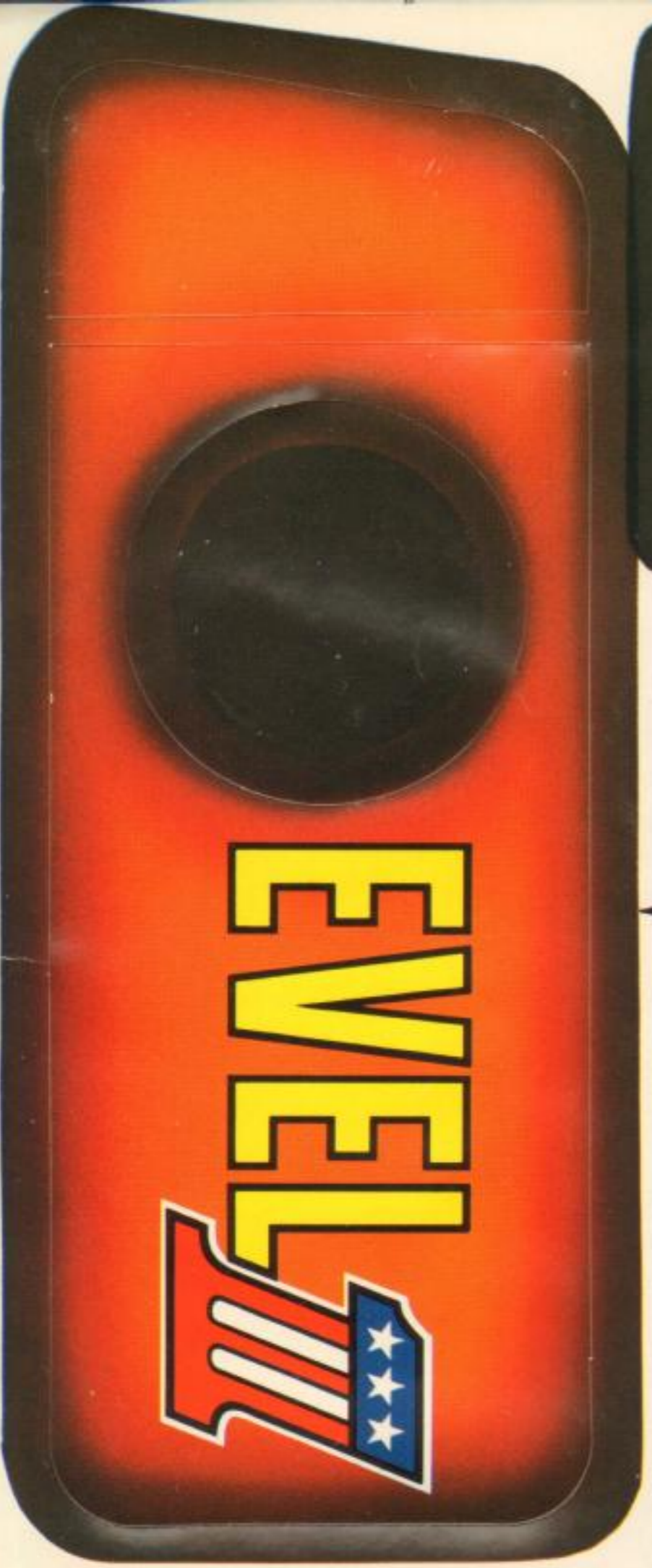

2. DIAGRAM 5. The BIKE RACK will hold any Evel Knievel bike. Insert the FRONT FORK of the BIKE into the WELL on the BIKE RACK. Insert the REAR WHEEL into the SLOT.

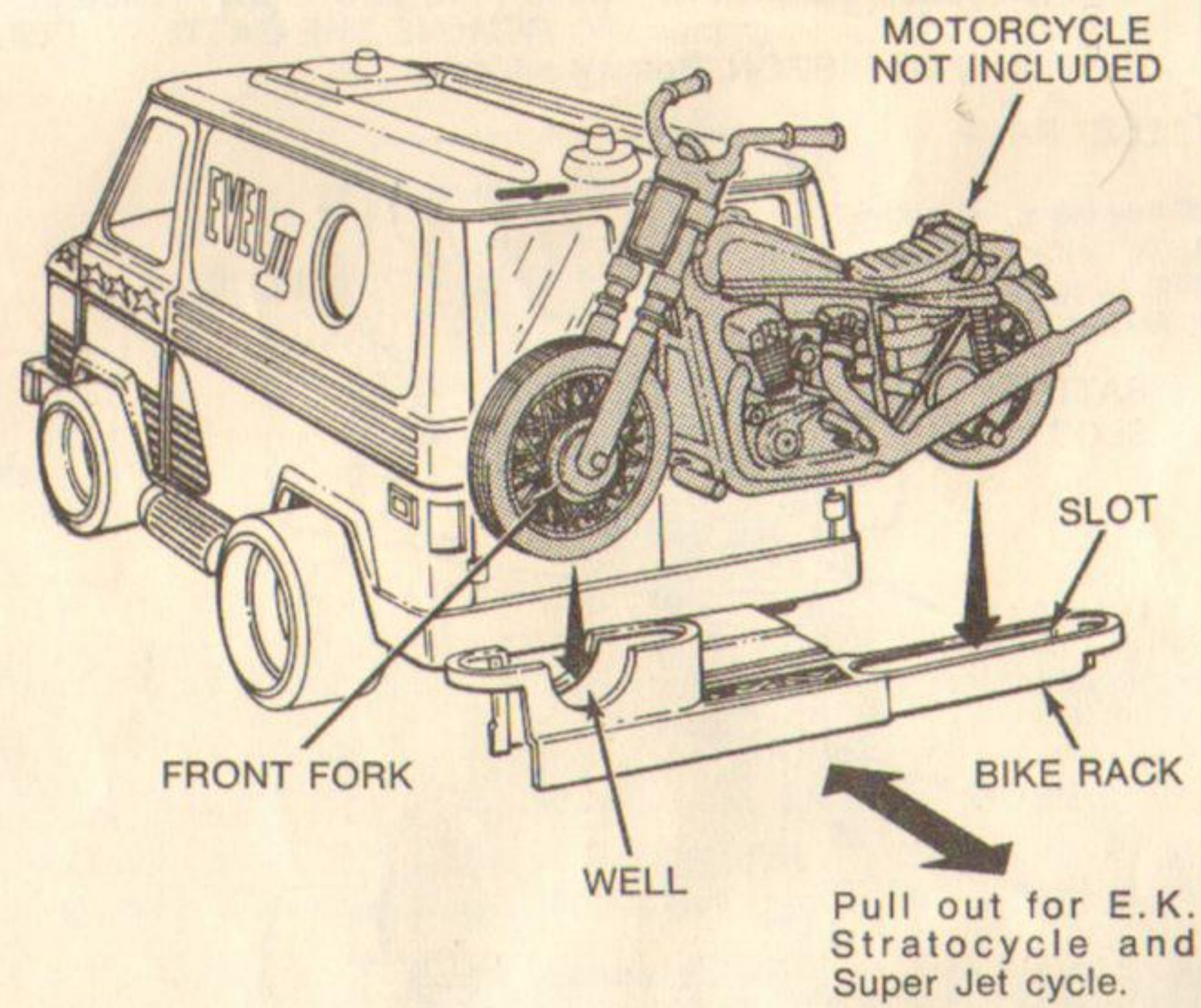

F. JUMP RAMP ASSEMBLY

1. DIAGRAM 6. FOR JUMPS: Fit TWO TABS at END of RAMP into TWO SLOTS at REAR of ROOF. Now you're ready to perform daredevil flips and jumps!

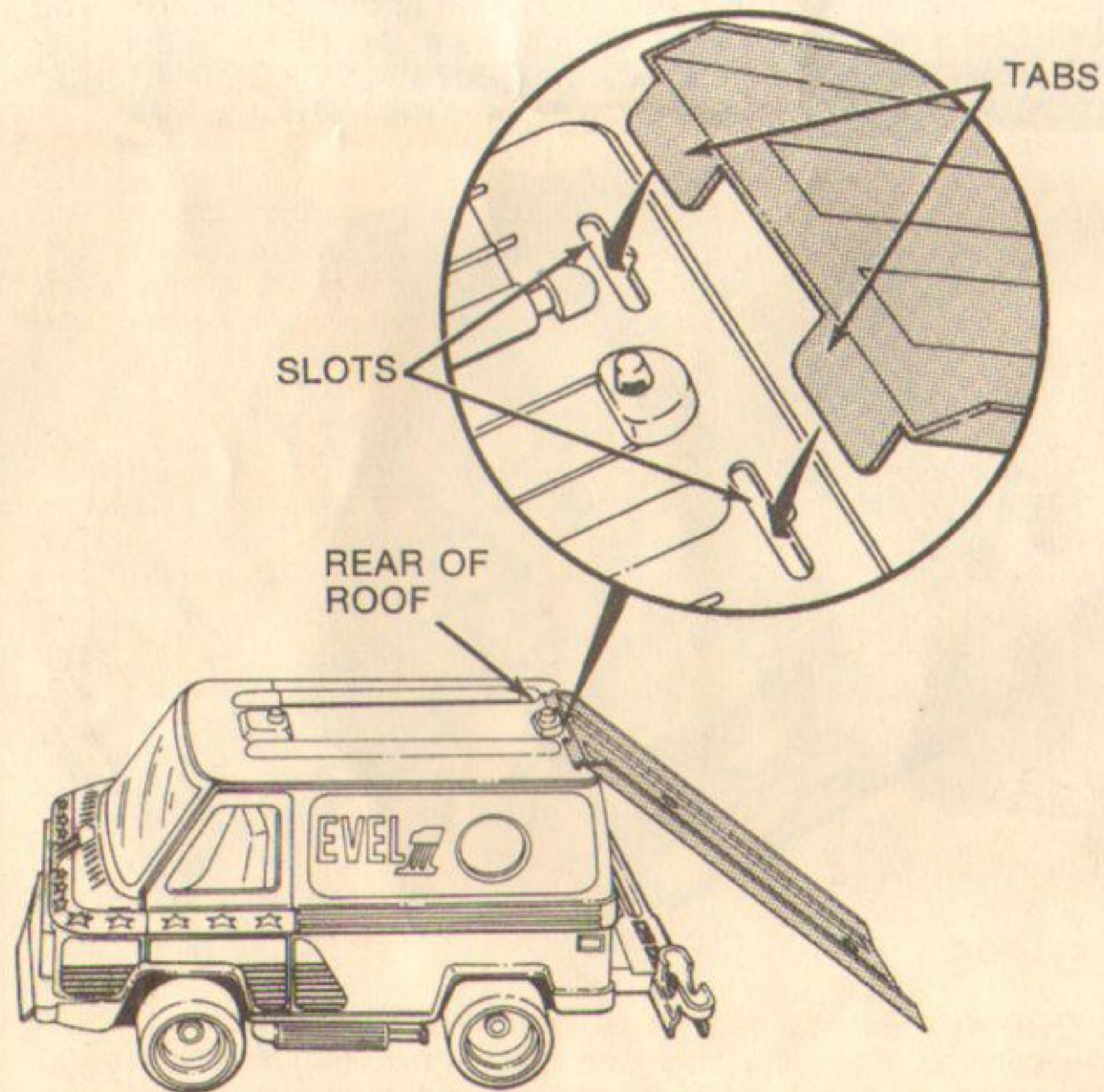

2. DIAGRAM 7. When not in use, carry the JUMP RAMP on the roof. Insert PEGS on ROOF through HOLES in RAMP with RAMP LABEL facing up.

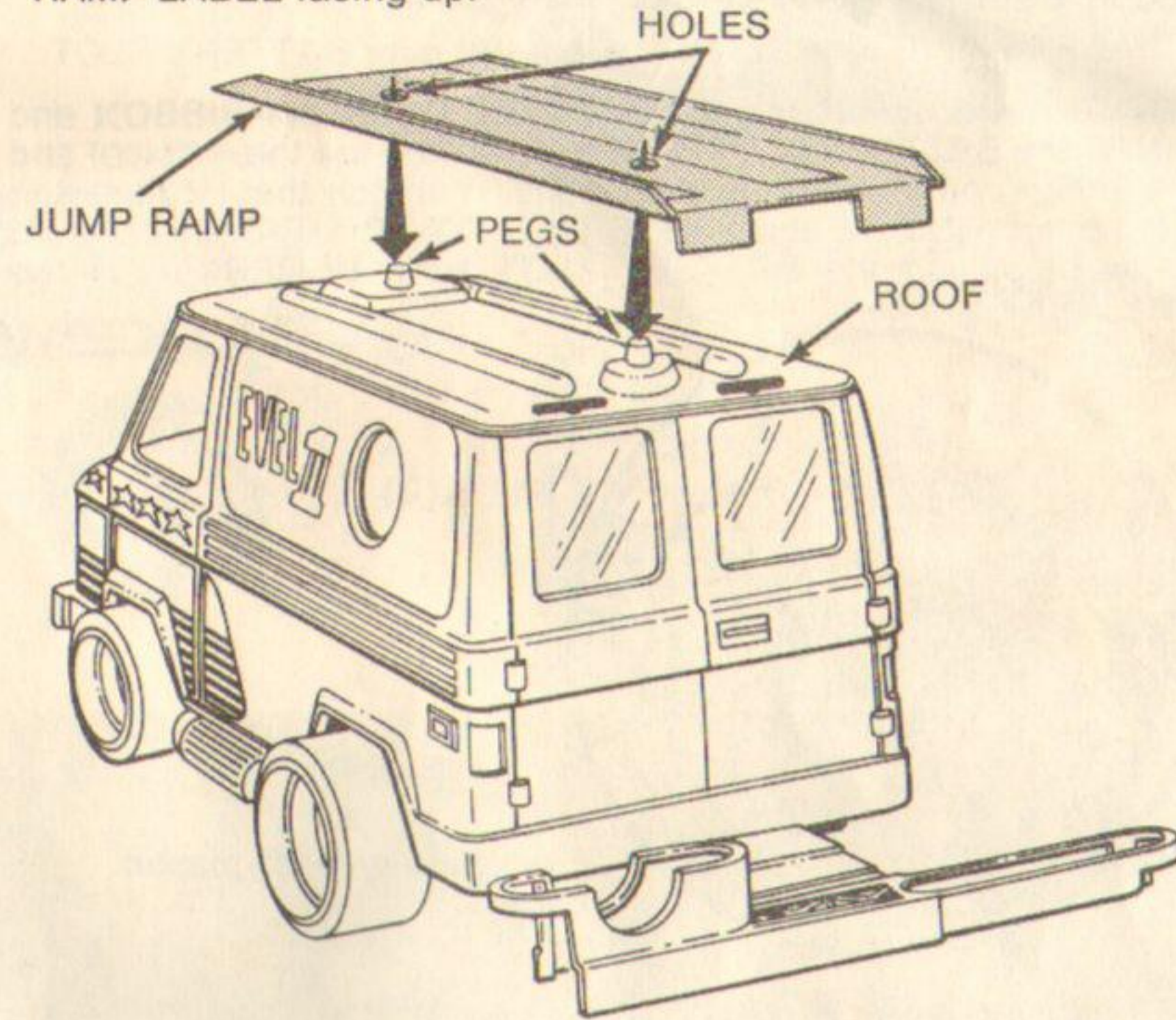

G. FLIPS AND JUMPS WITH YOUR EVEL KNEIVEL BIKE

CAUTION: As with all toys that go airborne it is advisable that the flight area be clear of other children and other obstacles. In this way chances of accidental injuries, damaged property and a broken toy can be avoided.

Place ENERGIZER about 2 feet away from ramp with front edge of Energizer parallel to lower end of ramp as shown. FLIPS: The Mid-Air Flip is one of the most difficult stunts. Position your Evel Knievel figure on bike with feet in stirrups and arms stretched out to the sides. Bend the figure forward so that its top half leans over the handlebars. Energize bike at a VERY FAST speed. Make sure Energizer is seated firmly on the floor as you turn the handle. When you think the bike is energized enough, STOP winding but HOLD ON TO THE HANDLE so that it does not move. Bike will launch itself up the ramp, over the Van and into a Mid-Air Flip!

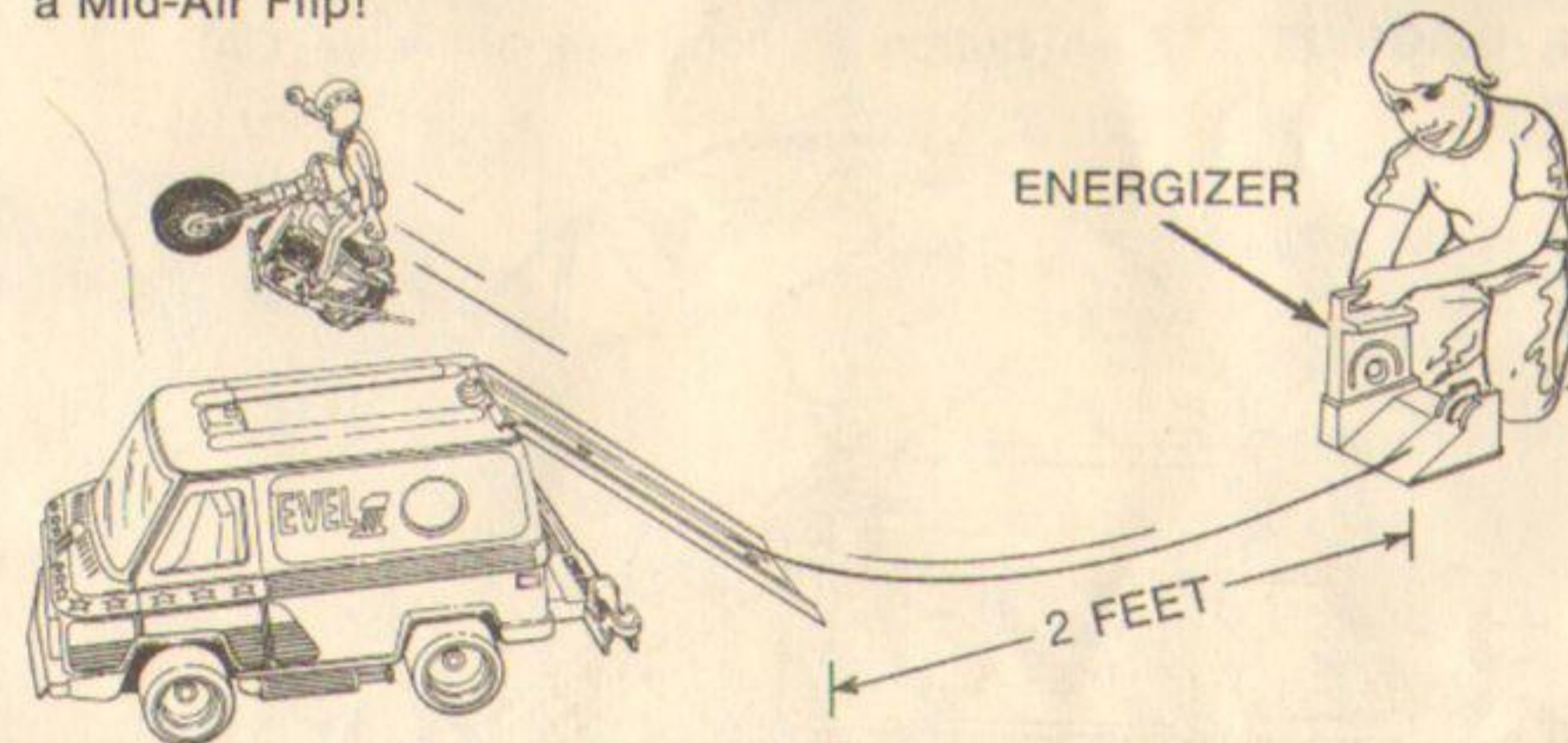

H. JUMPS

Seat Evel Knievel figure on bike with hands on handlebars and feet in stirrups. Energize bike and it'll send Evel Knievel soaring over the Van, and with perfect balance and continue its run!



CB VAN™

Ramp is illustrated offset to show door open.

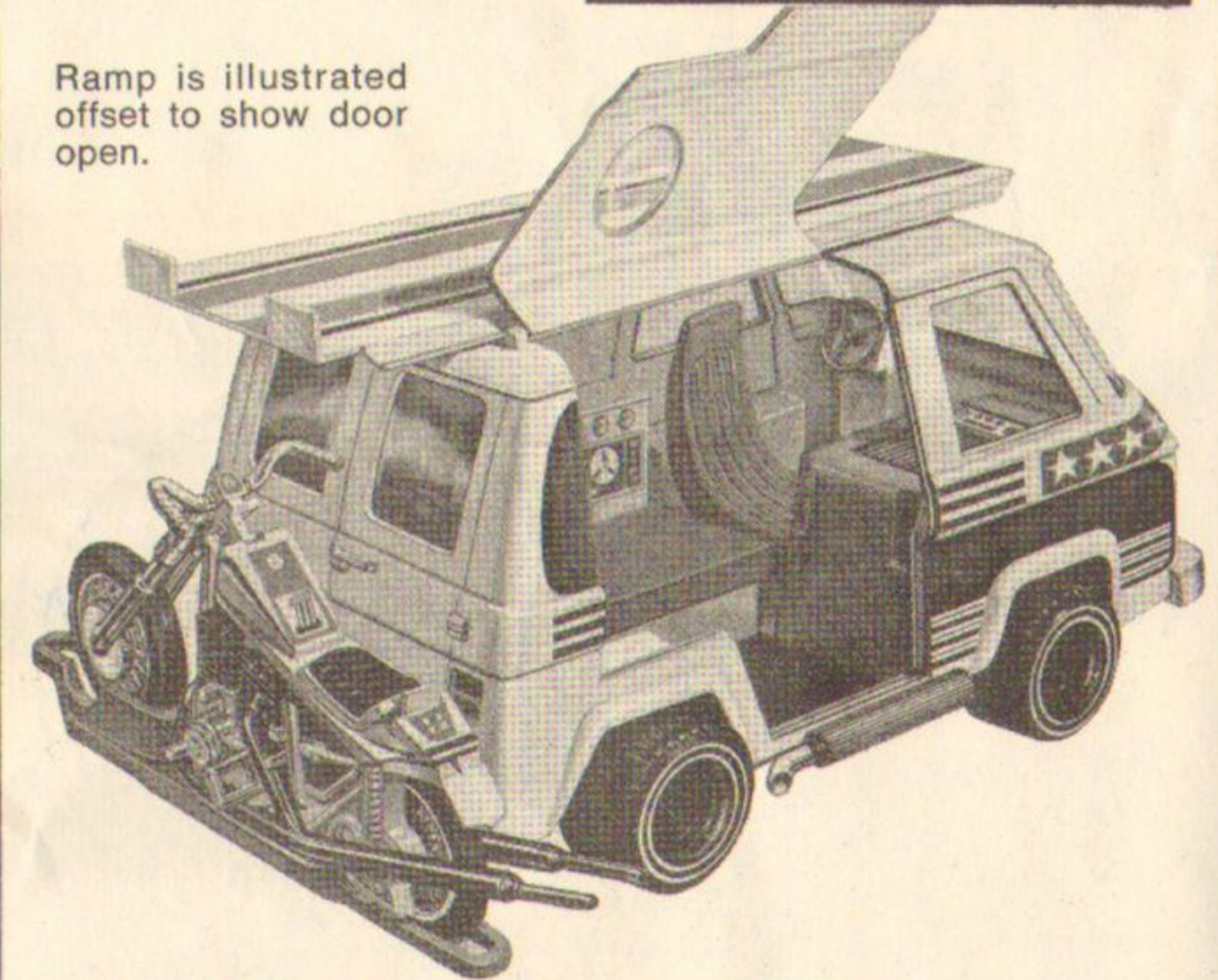

ASSEMBLY AND PLAY INSTRUCTIONS

Here's Evel Knievel's California-style van...with moveable doors, bike rack, jump ramp, bench storage area and a super voice unit that talks to you in Evel's own voice. It has lots of room for your E.K. figure & bikes...so get ready good buddy...it's time to get rollin' with the Evel One!

A. LABELS:

1. **DIAGRAM 1.** Remove one LABEL at a time from the backing sheet and apply the LABELS to the pieces and areas as shown.

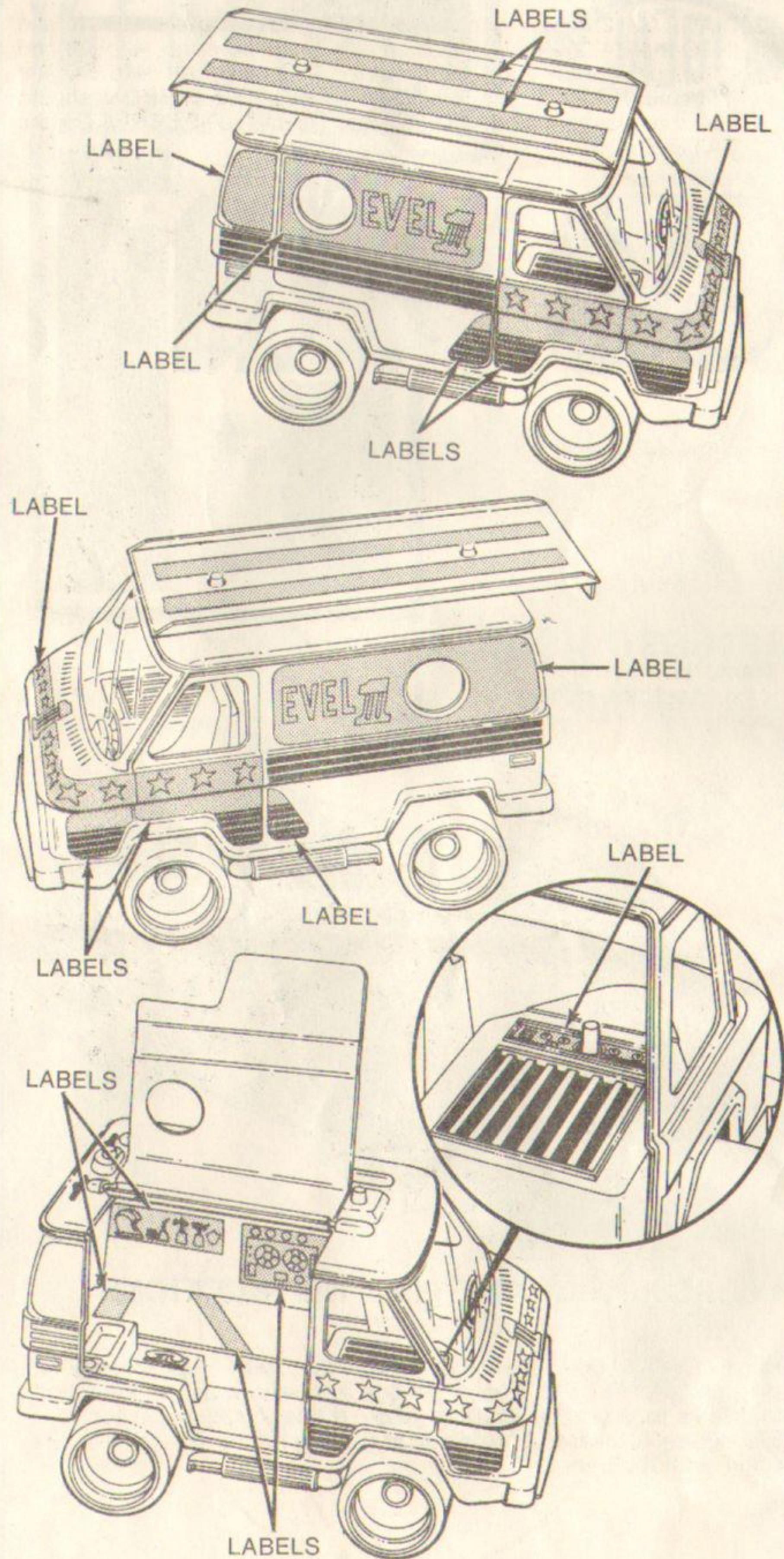

B. VOICE UNIT ASSEMBLY (requires one AA battery)

1. **DIAGRAM 2.** Turn CB VAN upside down.
2. **DIAGRAM 2.** Hold RIBBON straight out over BATTERY SLOT.
3. **DIAGRAM 2.** Insert one AA BATTERY OVER the RIBBON and INTO the BATTERY SLOT as shown. Make sure the + (plus) and - (minus) on the ends of the BATTERY match the + (plus) and - (minus) INSIDE the BATTERY SLOT. The RIBBON should now be inside the BATTERY SLOT lying UNDERNEATH the BATTERY.

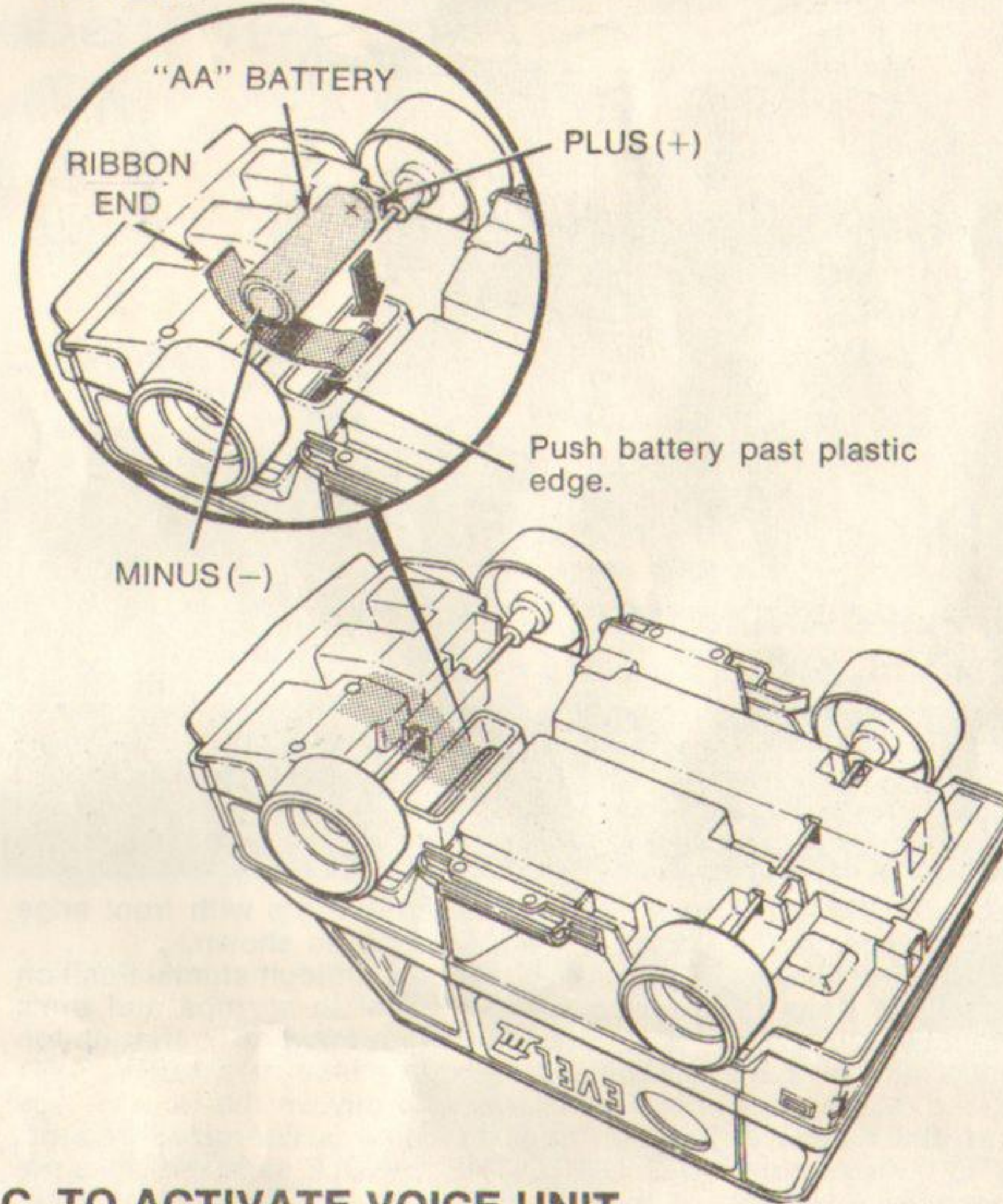

C. TO ACTIVATE VOICE UNIT

1. **DIAGRAM 3.** Push button on top of unit, inside CAB.

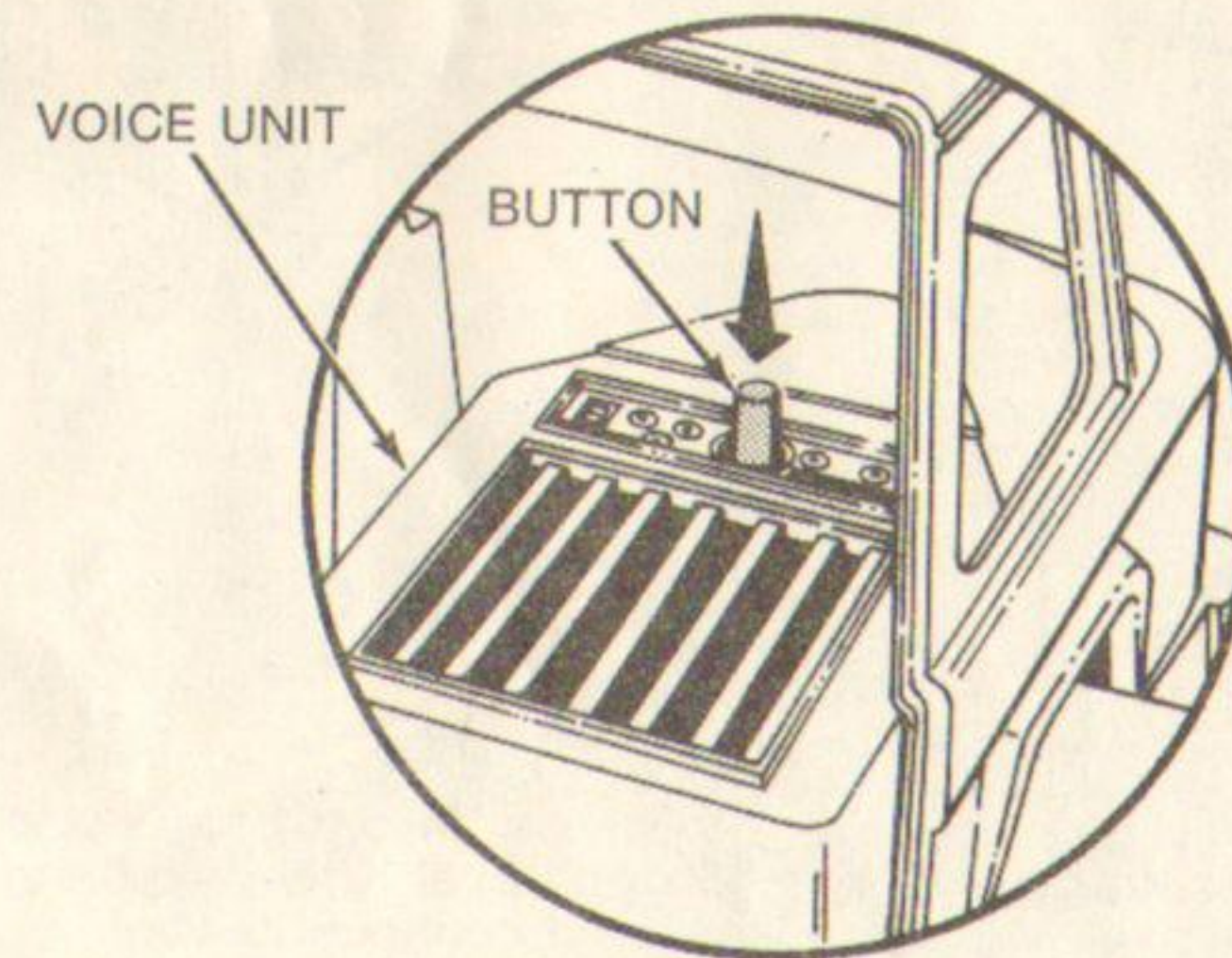

D. TO ADJUST VOICE SPEED

1. **DIAGRAM 4.** Remove the battery and slide the BUTTON located on the bottom of the BATTERY SLOT. To speed up the voice, slide the button toward the + (plus)... to slow it down, slide the button toward the - (minus) TO REMOVE THE BATTERY: Pull UP on END OF RIBBON. Battery will snap out.

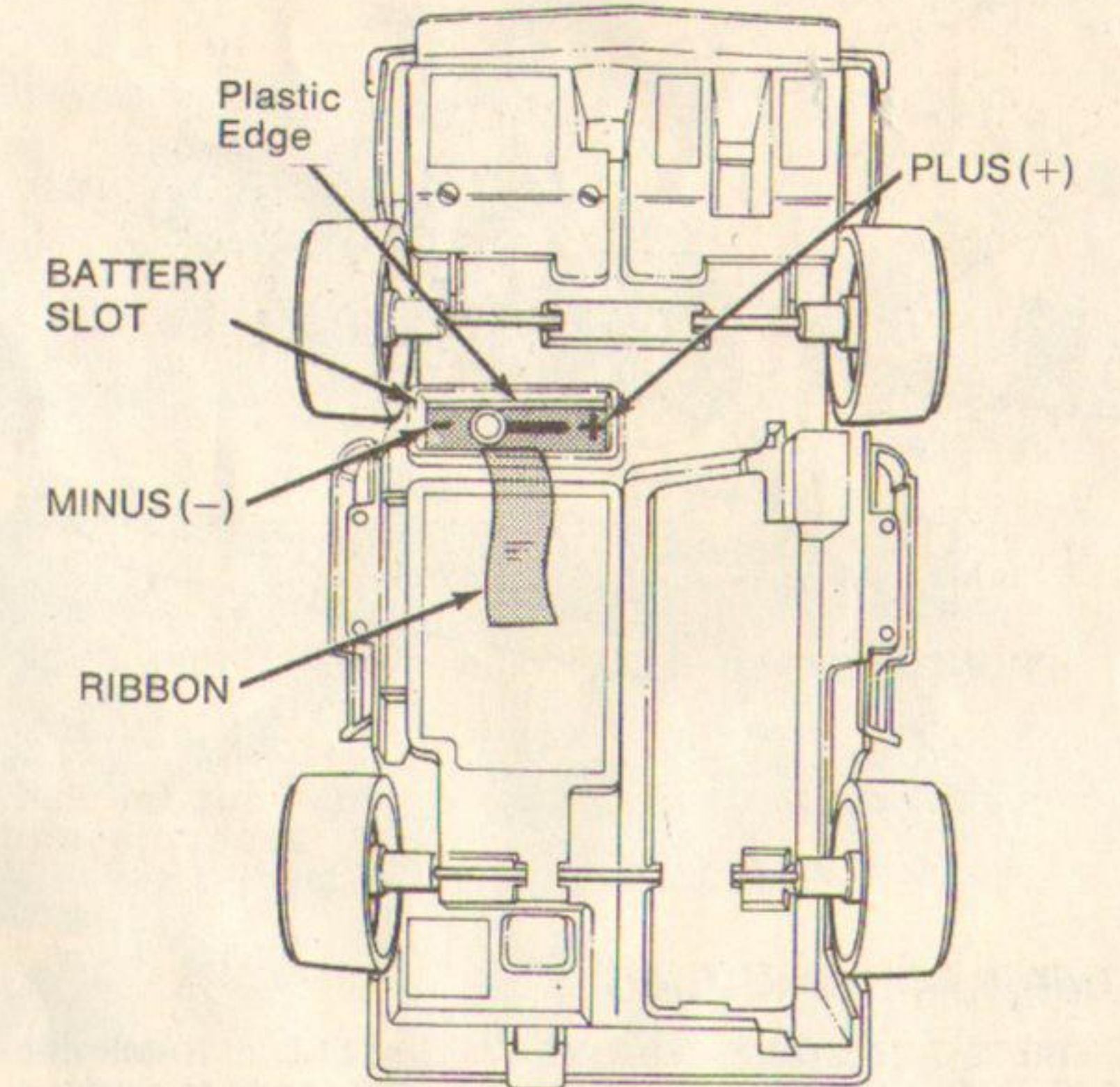

E. TO ASSEMBLE BIKE RACK

1. Slide the SUPPORTS into the SLOTS on underside of VAN. The SUPPORTS will snap in place just past the REAR AXLE. DO NOT REMOVE THE BIKE RACK ONCE IT IS LOCKED IN PLACE. TO DO SO MAY CAUSE DAMAGE TO THE VEHICLE.

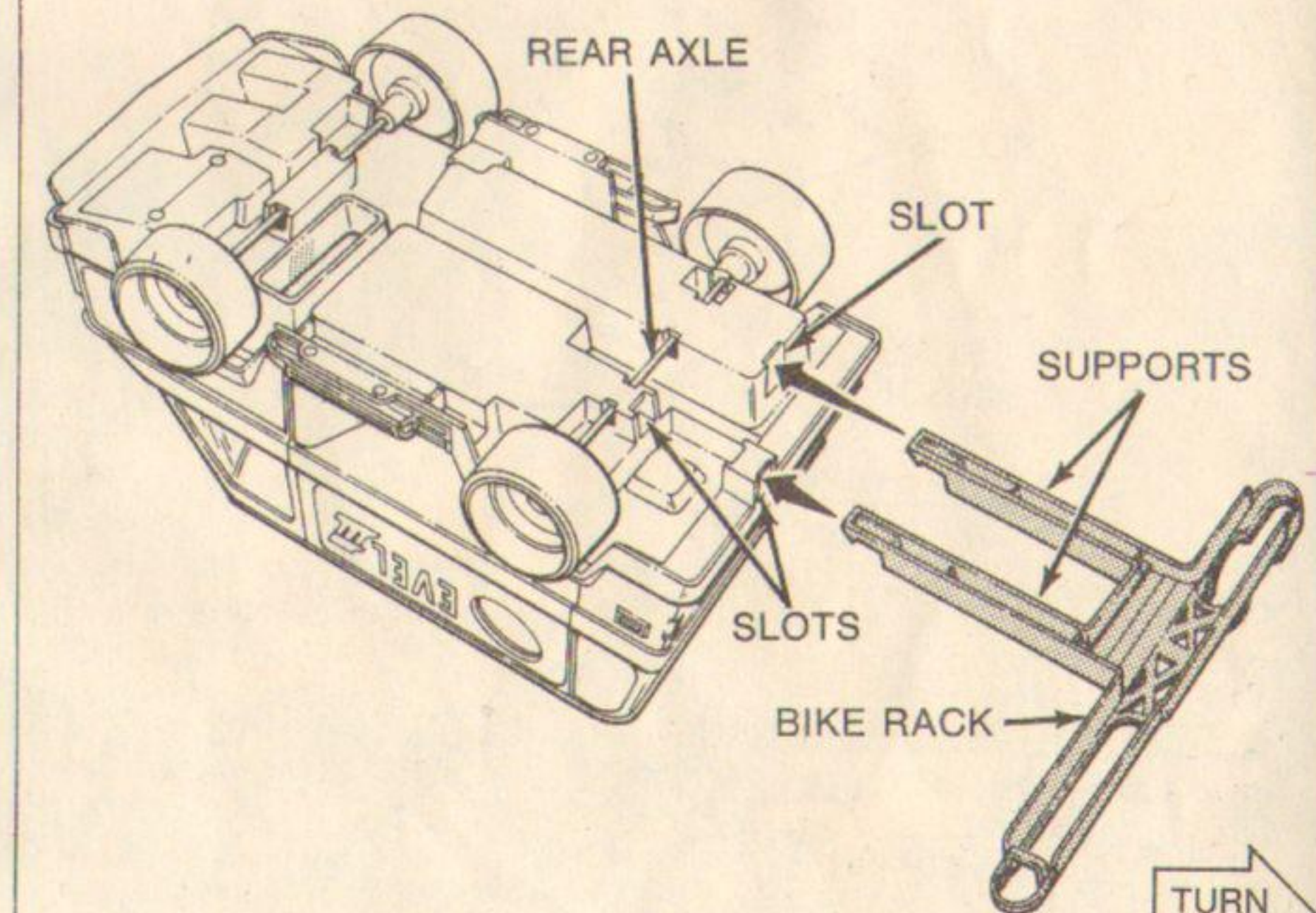

TURN PAGE